

realoffice

MAYLINE

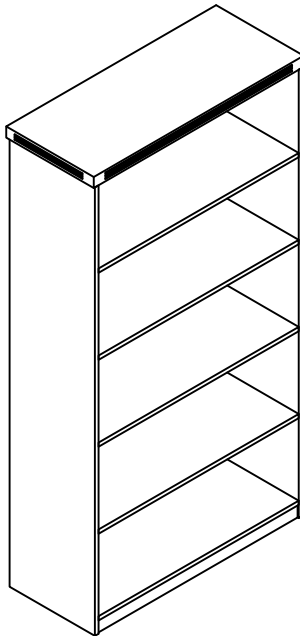







Aberdeen Series™
5 Shelf Bookcase
Model No. AB5S36

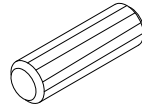
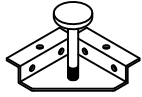
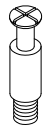

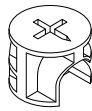
ASSEMBLY INSTRUCTIONS

CALL 1-800-822-8037 FOR ASSISTANCE

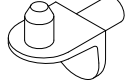





PARTS LIST

Name	Part	Qty.	Spare Qty	Name	Part	Qty.	Spare Qty
A	 REALS004 Wood Dowel	31	2	F	 REALS008 Corner Bracket w/ Glide	4	
B	 REALS003 Cam Post	26	2	G	 REALS005 Ø4 x 16mm	24	2
C	 REALS001 Cam Fastener	26	2	H	 REALS104 Grommet	2	
D	 REALS102** Cam Sticker	26	2	H1	 REALS230** Cap	4	
E	 REALS009 Shelf Support Pin	12	1		 AB5S36HB		

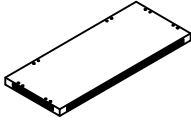
Items with HB are in hardware box.

**Denotes Color Code

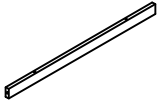
PARTS LIST

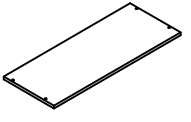
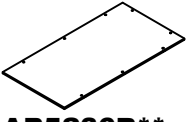
Name	Part	Qty.	Name	Part	Qty.
J	 ABS36J** Top	1	N	 ABS36N** Fixed Shelf	3
K	 ABS36K** Bottom	1	P	 AB5S36P** Left Side Panel	1
L	 ABS36L** Toe Kick	1	Q	 AB5S36Q** Right Side Panel	1
M	 ABS36M** Moveable Shelf	1	R	 AB5S36R** Back Panel	1

**Denotes Color Code

2

- 1** Insert Wood Dowels (A) into Bottom (K) and Fixed Shelf (N). Insert Cams (C) into Bottom (K) and Fixed Shelf (N). Install Cam Posts (B) into threaded inserts in Back Panel (Q). Attach Back Panel (Q) to Bottom (K) and Fixed Shelf (N) by turning Cams (C).

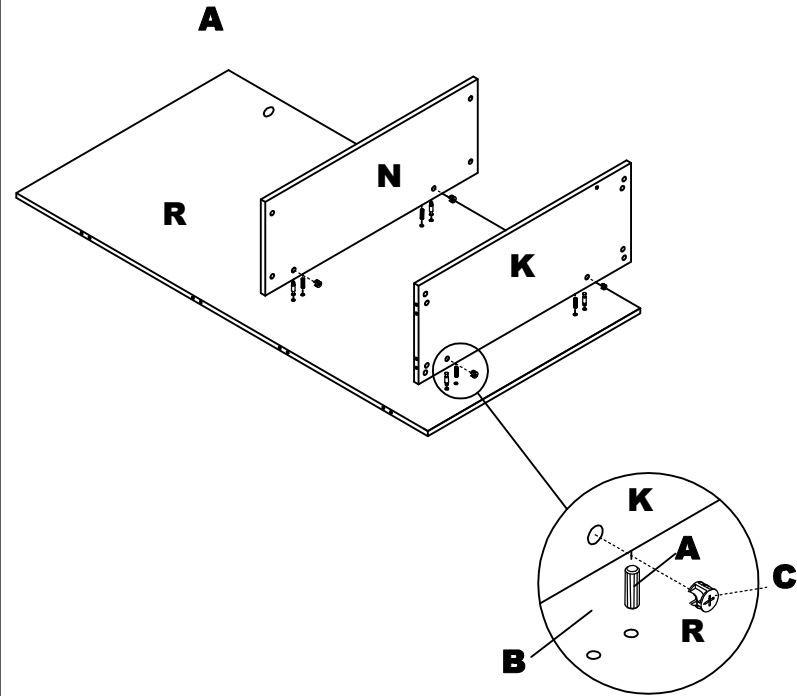

3

- 2** Insert Wood Dowels (A) into Back Panel (R), Bottom (K), Fixed Shelf (N), and Toe Kick (L). Insert Cams (C) into Back Panel (R) Fixed Shelf (N), and Bottom (K). Install Cam Posts (B) into threaded inserts in Right Side Panel (Q). Press Toe Kick (L) to Bottom (K). Attach Right Side Panel (Q) to Back Panel (R), Fixed Shelf (N), and Bottom (K) by turning Cams (C).

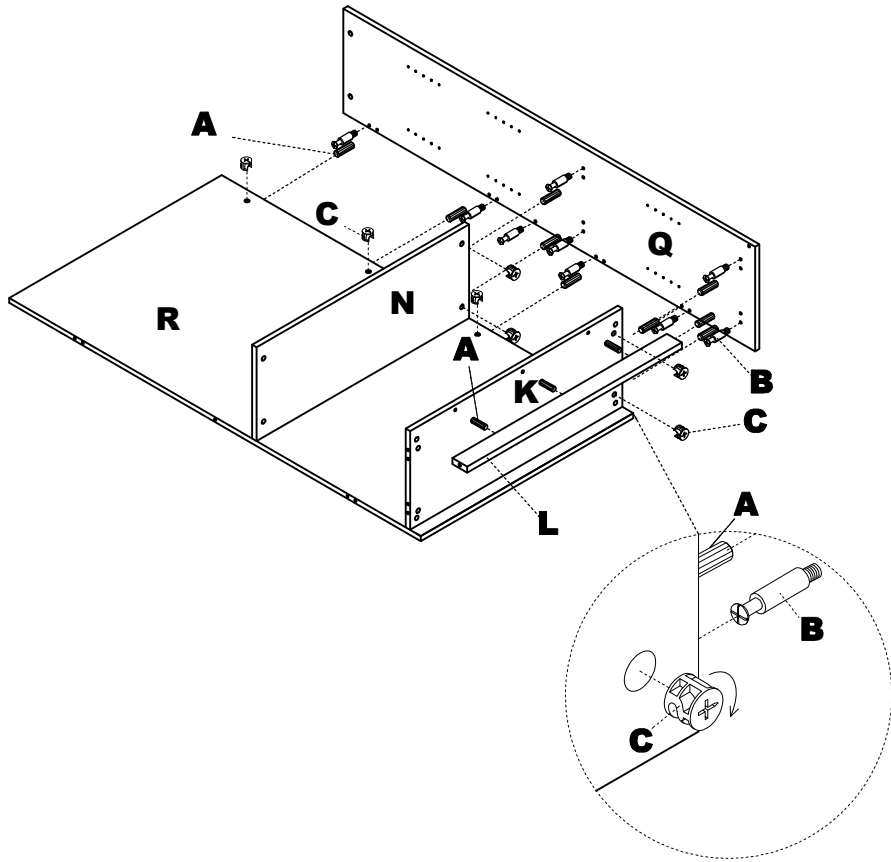

NOTE: The arrow on the face of the Cam (C) should point towards the Cam Post (B) for proper alignment.

4

- 3** Insert Wood Dowels (A) into Back Panel (R), Bottom (K), Fixed Shelf (N), and Toe Kick (L). Insert Cams (C) into Back Panel (R), Bottom (K), and Fixed Shelf (N). Install Cam Posts (B) into threaded inserts in Left Side Panel (P). Attach Left Side Panel (P) to Back Panel (R), Fixed Shelf (N), and Bottom (K) by turning Cams (C).

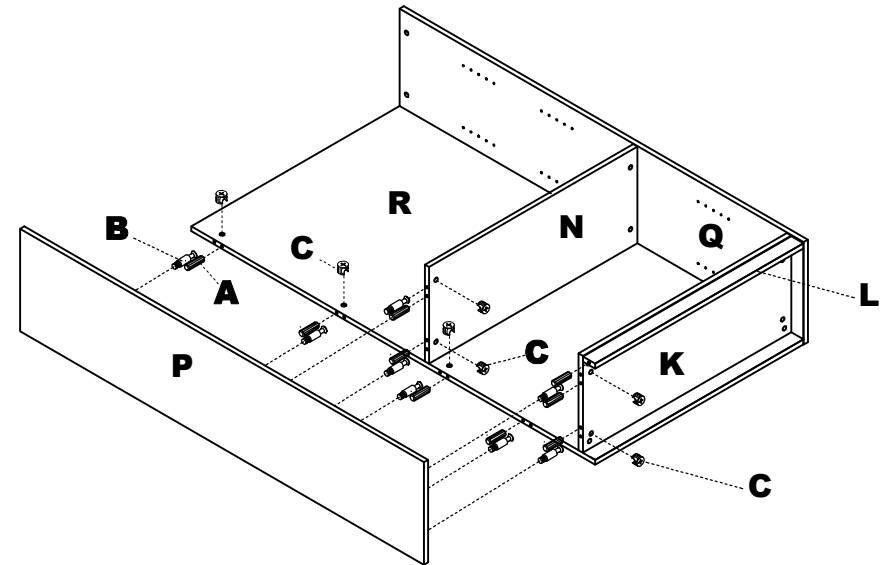

5

- 4** Insert Wood Dowels (A) into Back Panel (R) and Side Panels (P & Q). Insert Cams (C) into Back Panel (R) and Side Panels (P & Q). Install Cam Posts (B) into threaded inserts in Top (J). Attach Top (J) to Back Panel (R) and Side Panels (P & Q) by turning Cams (C).

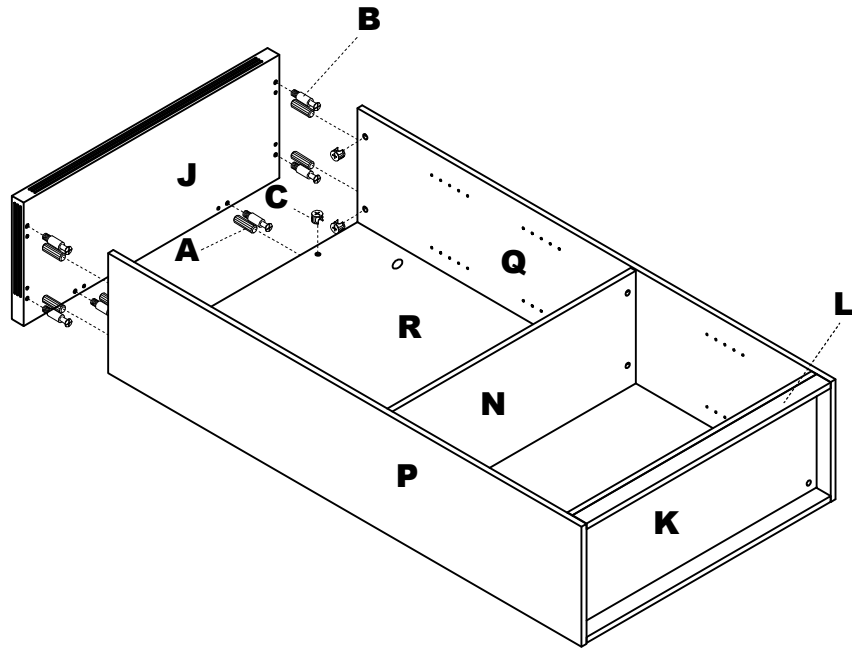

6

- 5** Attach Corner Brackets with Glides (F) using Screws (G).

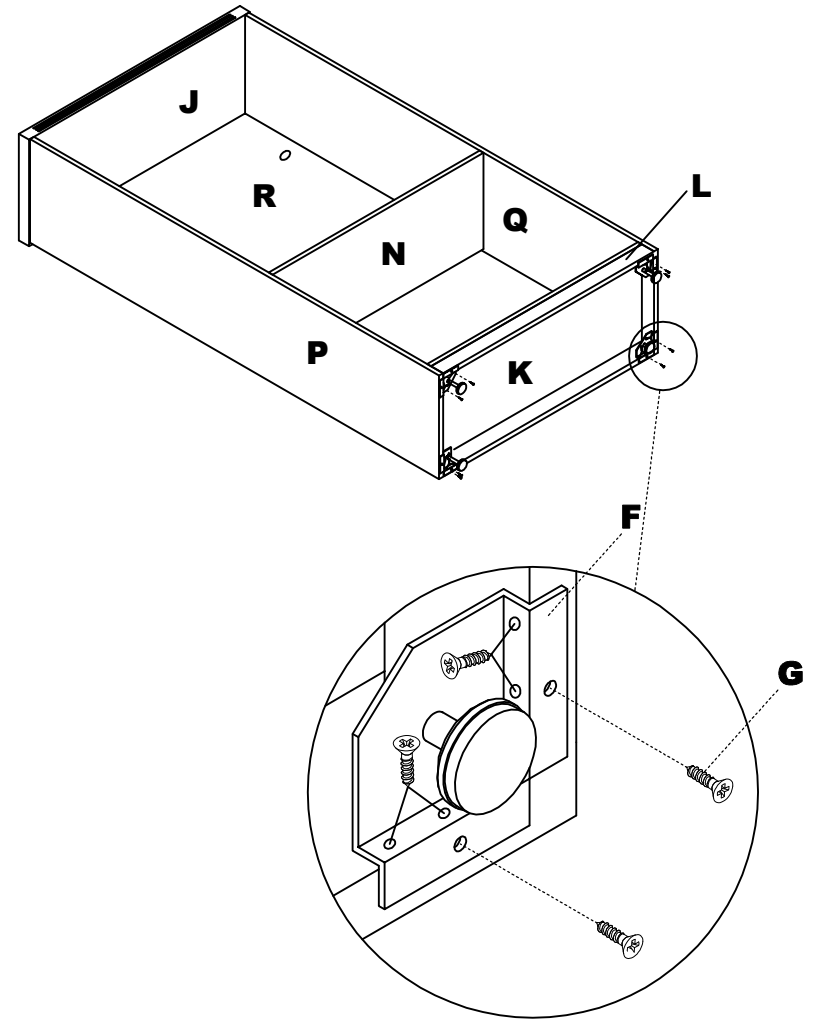

7

- 6** Install Shelf Support Pins (E). Insert Grommets (H) into Back Panel (R). Apply Cam Stickers (D) over exposed Cams (C). Insert Caps (H1) into adjustment holes for levelers.

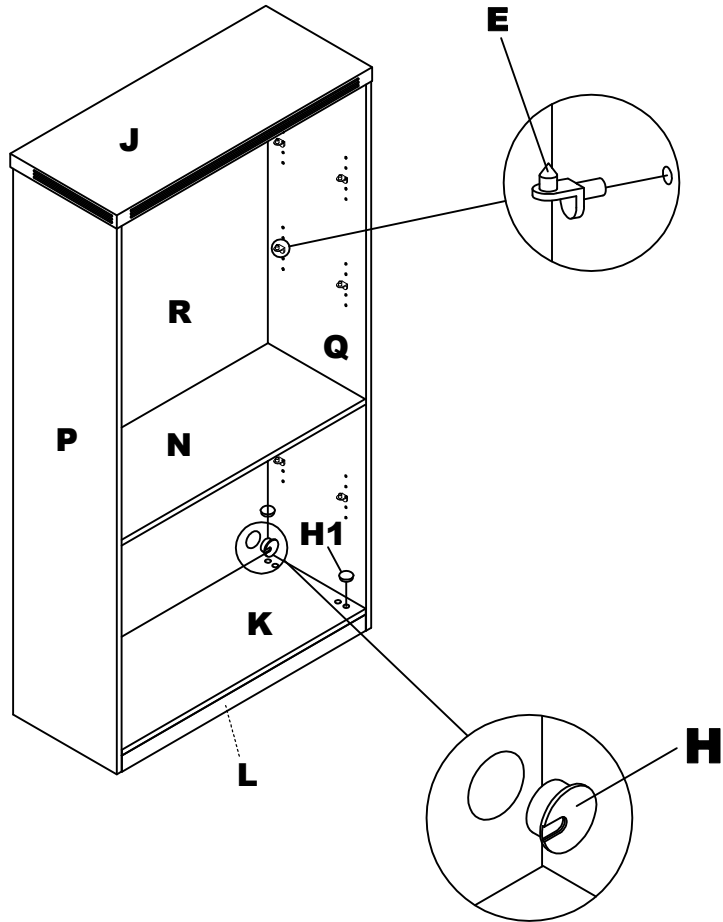

8

- 7** Install Shelves (M).

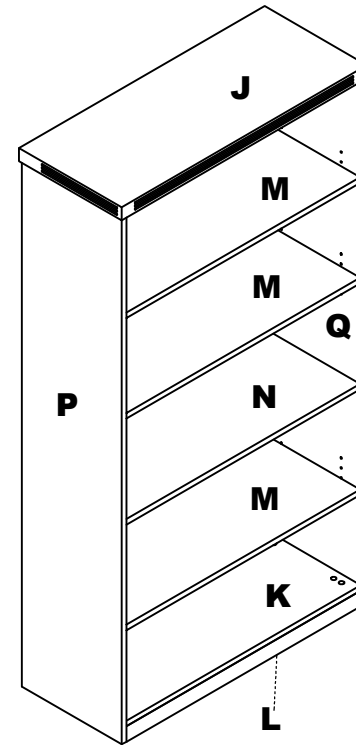

9